

CZT

SPECIFICATION FOR APPROVAL

CUSTOMER _____

CUSTOMER'S PART NO. _____ REV. _____

DESCRIPTION RJ45 ICM (1000 Base-T 1Port)

CZT'S PART NO. JDGD14100001 REV. C

ISSUE NO. _____

ISSUE DATE NOV.03,2014

<input type="checkbox"/> APPROVED	<input type="checkbox"/> REJECTED:
<input type="checkbox"/> APPROVED UNDER THE CONDITIONS:	

SuZhou Yihua Communicated Connector Co., Ltd.

Add: No.1558, Linhu East Road, Foho New&Hi-tech industrial Development Zone, Wujiang, Jiangsu, P.R.C.

TEL:+86-512-82078810

FAX:+86-512-82078858

DongGuan Yihua Electronic Co., Ltd.

Add: Yihua Holdings Industrial park, Cuntou district, Hu'men Town, Dongguan, Guangdong, P.R.C.

TEL:+86-769-8624 0111

FAX:+86-769-8624 0238

Note:

1. This specification is the proprietary of Yihua Communicated Connector Co., Ltd. and is not allowed to be revealed to third party without any written approval.
2. This specification is valid within 1 year before approval, and for any updated specification information required, please contact with CZT's sales window before order releases.

CZT

SPECIFICATION FOR APPROVAL

2. Revision Change Record

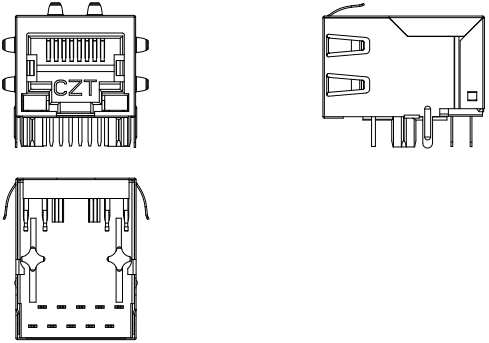
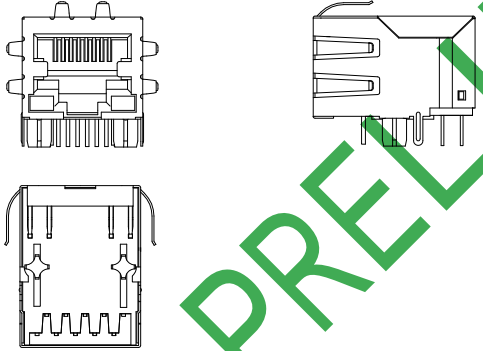
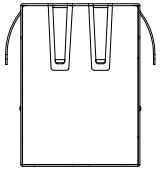
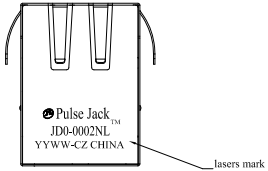
Customer Part No.: CZT Part No.: JDGD14100001 Part Name: RJ45 ICM(1000Base-T 1Port)					Rev.: C
Rev	Description	Drawn	Designed	Approved	Issue Date
A	Specification issued	ChenLingjuan	ZhangChao	Topup. Liu	AUG. 28 2014
B	Change From: 4-1. Mechanical Dimension:  To: 4-1. Mechanical Dimension: 	ChenLingjuan	ZhangChao	Topup. Liu	SEP. 12 2014
C	Change From: 5-1. Label: Plug In Side  To: 5-1. Label: Plug In Side 	ChenLingjuan	ZhangChao	Topup. Liu	NOV. 03 2014

PRELIMINARY



CZT

SPECIFICATION FOR APPROVAL

Customer Part No.:
 CZT Part No.: JDGD14100001
 Part Name: RJ45 ICM(1000Base-T 1Port)

Rev.: C



4. Mechanical Dimension and Notes:

4-1. Mechanical Dimension:

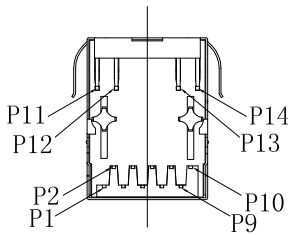
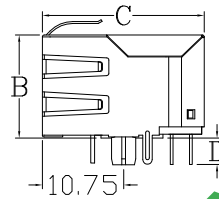
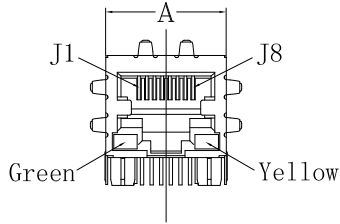

UNIT : mm / inch
 A = 15.90 / 0.626
 B = 13.63 / 0.537
 C = 21.35 / 0.841
 D = 3.50 / 0.126

Unless otherwise specified, all dimensions tolerances is $\pm 0.254 / 0.010$.

4-2. Notes:

1. CONNECTOR MATERIAL:
 HOUSING: THERMOPLASTIC BLACK UL94 V-0
 SHIELD: Brass
 SHIELD PLATING: NICKEL
 CONTACT: PHOSPHOR BRONZE
 CONTACT PLATING: SELECTIVE GOLD, 6 MICRO-INCHS MIN IN CONTACT AREA
2. PIN NOT ELECTRICALLY CONNECTED MAYBE OMITTED SEE ELECTRICAL DRAWING FOR OMITTED PINS
3. RJ45 CAVITIES CONFORM TO FCC RULES AND REGULATION PART 68.
4. THE PART IS RECOMMENDED FOR WAVE SOLDERING PROCESS PEAK SOLDERING TEMPERATURE IS 260° C MAX, 10 SECS MAX
5. OPERATING TEMPERATURE T=0° C TO +70° C.
6. STORAGE TEMPERATURE T=-40° C TO +85° C.

LED SPECIFICATION				
STANDARD LED	WAVELENGTH	Forward Current	Forward V(max)	TYP
GREEN	565nm	20 mA	2.4V	2.2V
YELLOW	590nm	20 mA	2.5V	2.1V

Drawn by
ChenLingjuan

Designed by
ZhangChao

Approved by
Topup.Liu

CZT

SPECIFICATION FOR APPROVAL

Customer Part No.:
CZT Part No.: JDGD14100001
Part Name: RJ45 ICM(1000Base-T 1Port)

Rev.: C



5. Label and Recommended PWB Layout and Suggested Panel Opening:

5-1. Label:

Plug In Side

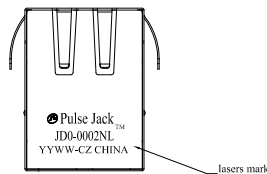

5-2. Suggested Panel Opening:

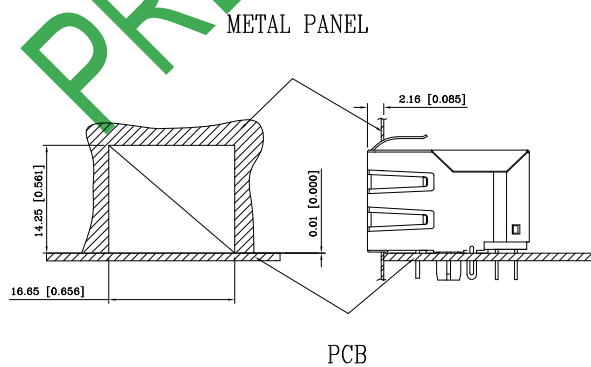

UNIT: mm / inch
Tolerances: ± 0.10 / 0.004

REFERENCE ONLY

CZT

SPECIFICATION FOR APPROVAL

Customer Part No.:
 CZT Part No.: JDGD14100001
 Part Name: RJ45 ICM(1000Base-T 1Port)

Rev.: C



5-3. Keep-Out Area (Component Side View):

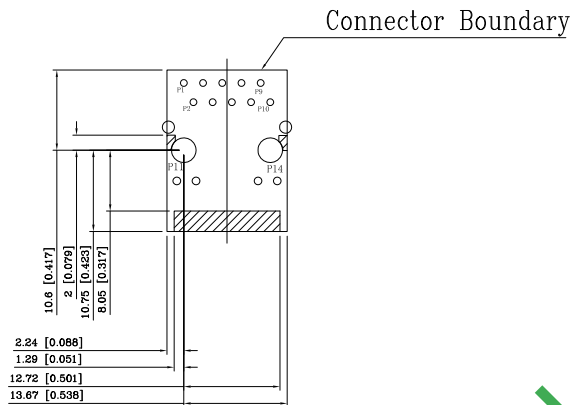

Plug-in side

UNIT: mm / inch
 Tolerances: ± 0.10 / 0.004

5-4. Recommended PWB Layout (Component Side View):

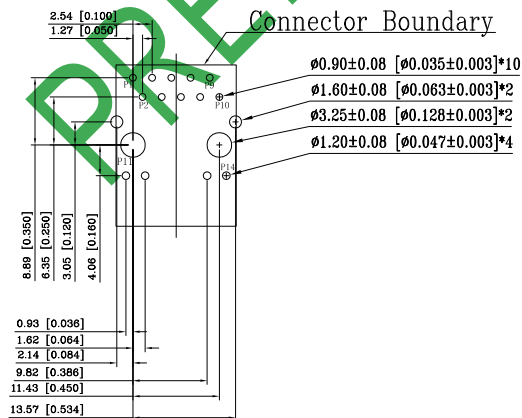

Plug-in side

UNIT: mm / inch
 Tolerances: ± 0.10 / 0.004

CZT

SPECIFICATION FOR APPROVAL

Customer Part No.:
 CZT Part No.: JDGD14100001
 Part Name: RJ45 ICM(1000Base-T 1Port)

Rev.: C



6. Circuit Schematic and Electronical Specifications:

6-1. Circuit Schematic:

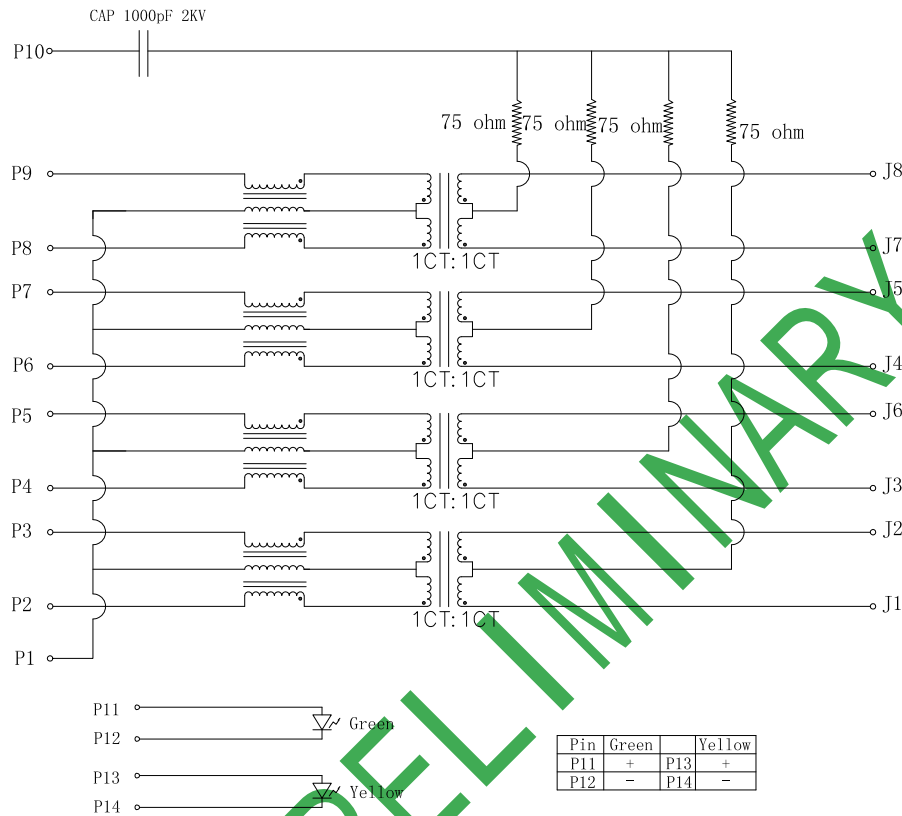

6-2. Electronical Specifications:

- 1.0 Turn Ratio @100KHz: (P2~P3):(J1~J2) = 1:1±5%
 (P4~P5):(J3~J6) = 1:1±5%
 (P6~P7):(J4~J5) = 1:1±5%
 (P8~P9):(J7~J8) = 1:1±5%
- 2.0 Primary Inductance: 350uH MIN @100KHZ,0.1V 8mA DC BIAS
- 3.0 DC Resistance: 1.2 OHMS MAX
- 4.0 Insertion Loss: 1-100MHz -1.0dB MAX
 100-125MHz -1.2dB MAX
- 5.0 Return Loss: 1-40MHz -16dB MIN
 40-60MHz -12dB MIN
 60-80MHz -10dB MIN
 80-100MHz -8dB MIN
- 6.0 Cross Talk: 1-100MHz -30dB MIN
- 7.0 COMMON TO COMMON MODE ATTENUATION: 1-100MHz -30dB MIN
- 8.0 Isolation: PHY Side to Line Side: 2250VDC